

Operator's Manual
SUPPLEMENT
Model No.
806B-0 & 806U-0

⚠ WARNING:

Read Engine
Owner's Manual,
Vehicle Operator's
Manual, and
Supplement
Carefully Before
Operating Vehicle.

Parts List



4404 Engle Ridge Drive, Fort Wayne, IN
ph (219) 432-1596 fx (219) 432-7870

**THIS VEHICLE IS FOR
OFF-ROAD USE ONLY**

BEFORE OPERATING THIS VEHICLE, THE OWNER AND/OR OPERATOR MUST UNDERSTAND THE VEHICLE WAS NOT DESIGNED OR MANUFACTURED TO MEET SPECIFICATIONS FOR USE ON STREETS, HIGHWAYS, OR THOROUGHFARES AND HAVE READ AND HAVE AN UNDERSTANDING OF ALL THE INSTRUCTIONS FOR SAFE ASSEMBLY AND OPERATION AS WELL AS THE INSTRUCTIONS GOVERNING THE ENGINE AND OTHER PORTIONS OF THE VEHICLE.

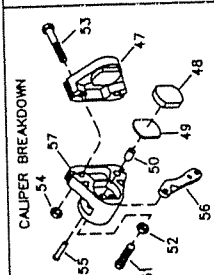
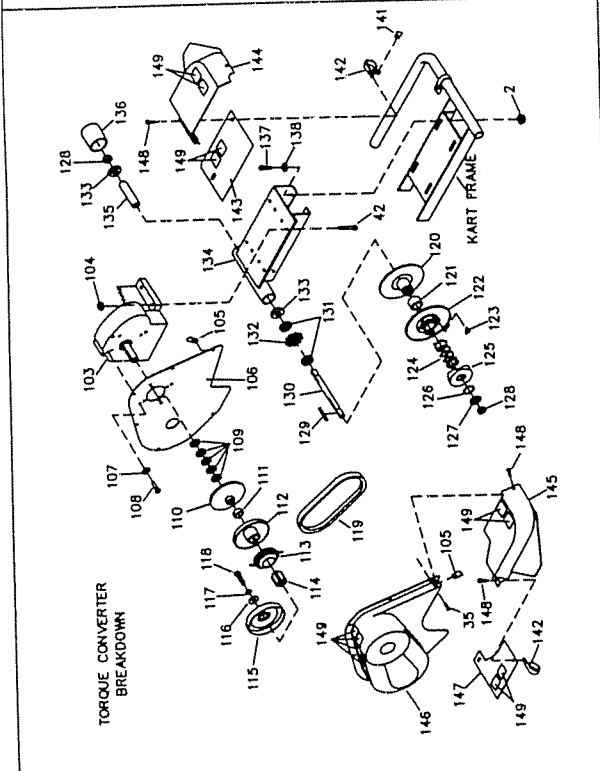
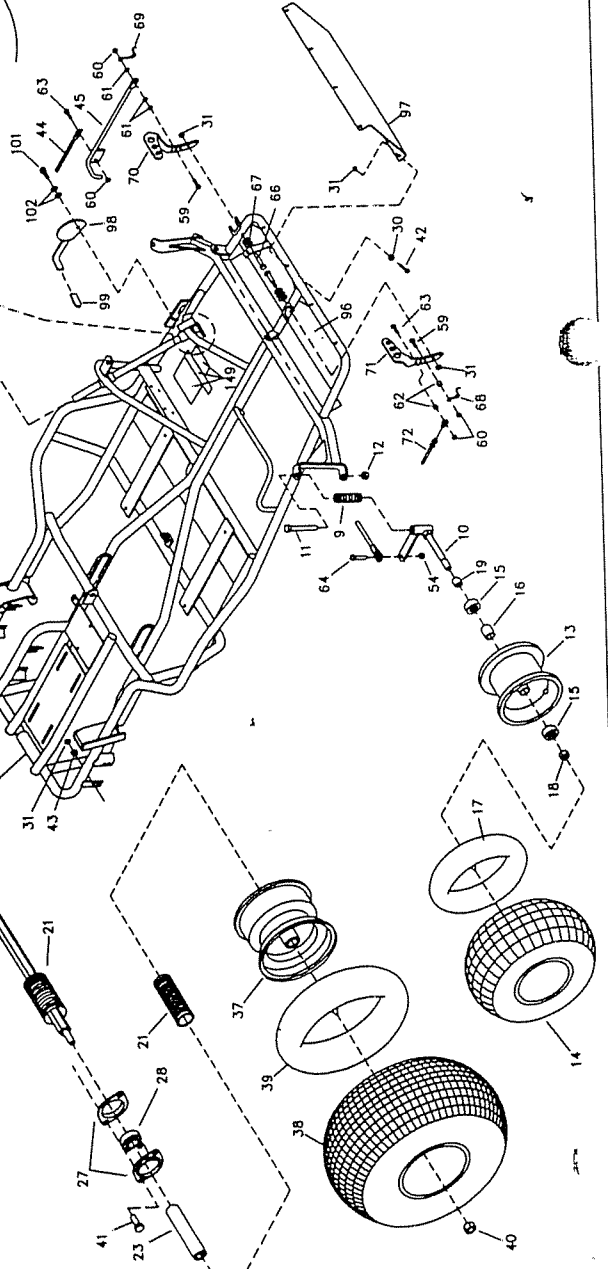
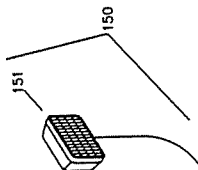
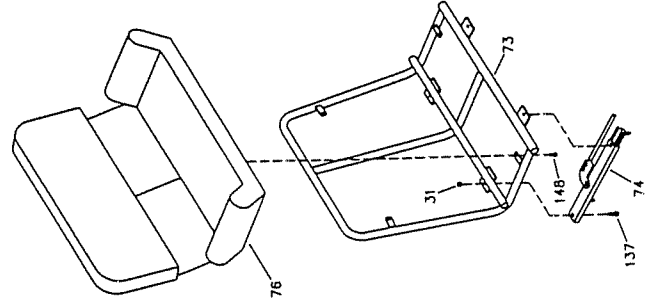
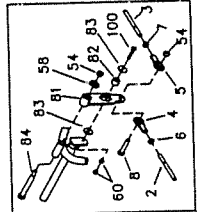
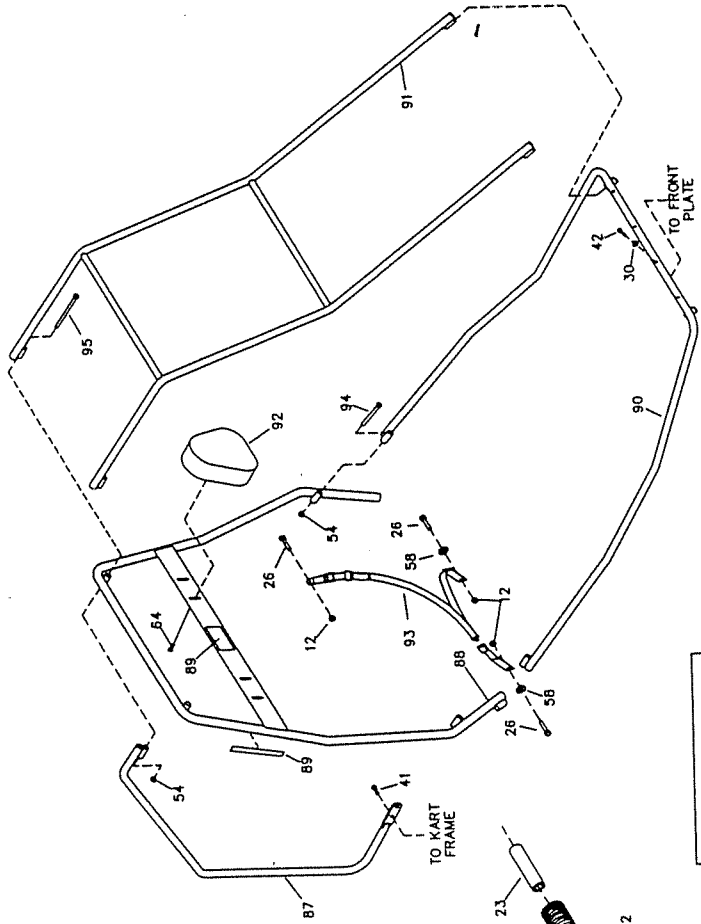

CALIPER BREAKDOWN

TORQUE CONVERTER BREAKDOWN

Ref	PN	Description	Ref	PN	Description	Ref	PN	Description
1	8675-7	Frame	52	3932	Nut, Jam	104	1263	Nut, 5/16-18 Whiz Flange
ASM	8342	Tie Rod Asm (incl. 2, 4-7)	53	9158	Bolt, 3/8-16 x 2-1/4"	105	2449	Nut, Tinnerman
ASM	4618	Tie Rod Asm (incl. 3-7)	54	9085	Nut, 3/8-16 Toplock	106	8200	Cover Panel
2	8341	Tie Rod, 23 inch	ASM	6534	MB-1 Service Kit (incl. 55-57)	107	9080	Washer, 5/16 Flat
3	3224	Tie Rod, 8-3/4 inch	55	*	Groove Pin	108	9101	Bolt, 5-16-24 x 1/2"
4	1414	Rod End - RH	56	*	Lever	109	1194	Washer, 3/4 Flat
5	1415	Rod End - LH	57	*	Brake Housing	ASM	5957	Driver Pulley Asm (incl. 110-115)
6	9092	Nut, 3/8-24 RH Jam	58	9022	Washer, 1/2 Flat	110	*	Stationary Sheave
7	9024	Nut, 3/8-24 LH Jam	59	1847	Bolt, 1/4-20 x 1"	111	200349	Bushing
8	9145	Bolt, 3/8-16 x 1-3/4"	60	9057	Nut, 1/4-20 Toplock	112	*	Moveable Sheave
9	8448	Compression Spring	61	1854	Washer, No. 14 Flat	113	*	Shoe Assembly
10	2457-2Z	Spindle, Right	62	1389	Bushing, 1/4" ID x 5/16	114	*	Hub
NI	2458-2Z	Spindle, Left	63	9160	Bolt, 1/4-20 x 7/8"	115	*	Drum
11	8453	Bolt, 1/2-13 x 6-1/2"	64	9146	Bolt, 3/8-16 x 1-1/2"	116	1398	Washer, Flat
12	1012	Nut, 1/2-13 Toplock	65	5839	Bolt, 1/4-20 x 3/4" Flanged Whiz	117	1124	Washer, 5/16 Split Lock
13	9309FP	Wheel Assembly, Front (incl. 14-16)	66	1447	Pedal Bolt	118	8204	Bolt, 5-16-24 x 2-1/4"
14	4915	Tire, 145/70 x 6 Knobby	67	9091	Washer, 3/8 Flat	119	8192	Belt
15	5090	Bearing, 5/8 ID	68	9503	Spring, Right Wound	ASM	8191	Driven Pulley Asm (incl. 120-126)
16	5950	Spanner, 5/8 ID x 2-1/8"	69	9502	Spring, Left Wound	120	*	Stationary Sheave
17	3802	Inner Tube, 6" (Repair Part Only)	70	1436-16	Brake Pedal	121	*	Bushing
18	1046	Nut, 5/8-11 Toplock	71	6309-16	Throttle Pedal, Trimmed	122	*	Moveable Sheave
19	5157-16	Spacer, 5/8 ID x 3/4"	72	8251	Throttle Cable	123	6804	Button, Nylon
20	8757-16	Axle Weldment	73	8688-2	Seat Frame Weldment	124	6805	Spring
21	K806-01	Axle Guard Kit	74	8655	Seat Slide Pair	125	*	Cam
22	6314H	Brake Rotor	75	*****		126	2477	Retaining Ring
23	4662-16	Spacer, 1" ID x 4-1/4"	76	8692	Seat Back/Boltom	127	8193	Washer, Cup
24	4913-16	Spacer, 1" ID x 3"	77	6038	Steering Wheel	128	9155	Nut, 5/8-11 Jam
25	*****		78	9080	Bolt, 1/4-20 x 2-3/4"	129	3403	Key, 3/16 sq x 2"
26	9188	Bolt, 1/2-13 x 1-1/2"	79	11072	Stop Switch Assembly (806U-0 only)	130	8219	Jackshaft
27	6617	Bearing Flange	NI	9799	Stop Switch Assembly (806B-0 only)	131	1119	Spacer, 5/8 ID x 1/8"
28	3941H	Bearing, 1" ID	80	1406	Wire Harness Extension (806B-0 only)	132	8720	Sprocket, 9T #420
29	*****		81	1848	Bolt, 1/4-20 x 1-1/4"	133	5090	Bearing
30	9060	Washer, 5/16" Flat	82	9834-2	Steering Crank Weldment	134	8908	Chassis
31	1189	Nut, 5/16-18 Toplock	83	9873	Cam Follower Bearing	135	2430	Spanner
32	9186	Bolt, 5/16-18 x 1-1/2 GR5	84	9872	Washer, 1/4 Flat	136	8194	Cap, Plastic
ASM	6420H	Sprocket Asm. (incl. 34-37)	85	9871	Shoulder Bolt, 1/2 x 3	137	2264	Bolt, 5/16-18 x 3/4"
33	6282	Sprocket 420P 54T	86	9343	Chain, 420 x 71 Links plus Master Link	138	9030	Washer, 5/16 Int. Lock
34	6280H	Sprocket Hub	87	2037	Master Link, 420 Chain	139	*****	
35	9006	Bolt, 1/4-20 x 1/2" Whiz Flange	88	8702-7	Rear Bar	140	*****	
36	6701	Bolt, 5/16-18 x 1-1/4" SHCS	89	8700-7	Center Bar	141	8227	Nut, Tinnerman
37	10381	Wheel Asm, Rear (incl. 38)	90	11329	Decal Sheet, Center Bar Warnings	142	8266	Loop Clip 1"
38	3548	Tire, 18/9.5 X 8" Tubeless	91	8699-7	Front Bar	143	8443	Deck Cover Right
39	1430	Inner Tube, 8" (Repair Part Only)	92	8701-7	Overhead Bar	144	8441	Caliper Cover, Right
40	9162	Nut, 3/4-10 Toplock	93	6320	Headrest	145	8440	Caliper Cover, Left
41	9176	Bolt, 5/16-18 x 1"	94	8373	Seal Belt, Shoulder / Lap	146	8199	Cover
42	6573	Bolt, 5/16-18 x 1-3/4"	95	2386	Bolt, 3/8-16 x 3-1/2"	147	8442	Deck Cover Left
43	9674-16	Spacer, 3/8 ID x 3/8"	96	6452	Bolt, 3/8-16 x 5"	148	1876	Bolt, 1/4-20 x 5/8" Whiz Flange
44	10505-2	Brake Rod Rear	97	1441	Decal, Front Floor Pan Scuff	149	11330	Decal Sheet, Engine & Main Frame Warnings
45	10506-16	Brake Rod Front	98	10490-2	Front Plate	150	11347	Headlight Asm (incl. 151) (806U-0 only)
46	8197	Brake Caliper (incl. 47-57)	99	8673-2	Parking Brake Handle	151	10879	Headlight (806U-0 only)
ASM	9810	Brake Pad Service Kit (incl. 47-49)	100	4900	Brake Handle Cover	NI	9247R5	Assembly Instructions
47	*	Anvil w/ Lining	101	1849	Bolt, 1/4-20 x 1-1/2"	NI	6477	Dingo Operator's Manual
48	*	Brake Lining	102	9172	Bolt, 3/8 x 1/4 Shoulder	NI	2684E	Tecumseh Engine Manual
49	3928	Backing Plate	103	6441	Washer, 3/8 ID Spring			
50	3930	Actuator Pin	103	5533	Engine, Tec 6hp OHV (806B-0)			
51	3931	Adjuster Pin		10131	Engine, Tec 6hp OHV w/Coil (806U-0)			